



BILWINCO

YOUR WEIGH TO SOLUTIONS

BILWINCO

MULTI • CHECK

we know what's inside

YOUR WEIGH TO

SOLUTIONS

Dear Valued Customer

“

It is with great pleasure that I introduce to you our latest innovation in precision weighing technology – our Multihead Weigher product catalogue. Every day we strive to produce this comprehensive range of cutting-edge solutions designed to revolutionize your processes. We understand the pivotal role that accuracy and efficiency play in your operations. That's why our team of engineers and experts have tirelessly worked to develop a range of Multihead Weighers that exceed industry standards in performance, reliability, and versatility. This catalogue showcases a diverse array of models tailored to meet the unique needs of various industries, from food and pharmaceuticals to hardware and beyond. Whether you require high-speed packaging for small items or precision weighing for delicate products, we have the perfect solution to streamline your production line. With advanced features such as intelligent software algorithms, user-friendly interfaces, and robust construction, our Multihead Weighers are engineered to optimize productivity while minimizing downtime and waste. We are committed to providing you with the tools you need to stay ahead in today's competitive marketplace. I invite you to explore our catalogue and discover how our Multihead Weigher solutions can elevate your packaging operations to new heights of efficiency and accuracy.

Thank you for choosing BILWINCO as your trusted partner in innovation.



CLAUS PEDERSEN, OWNER & CEO

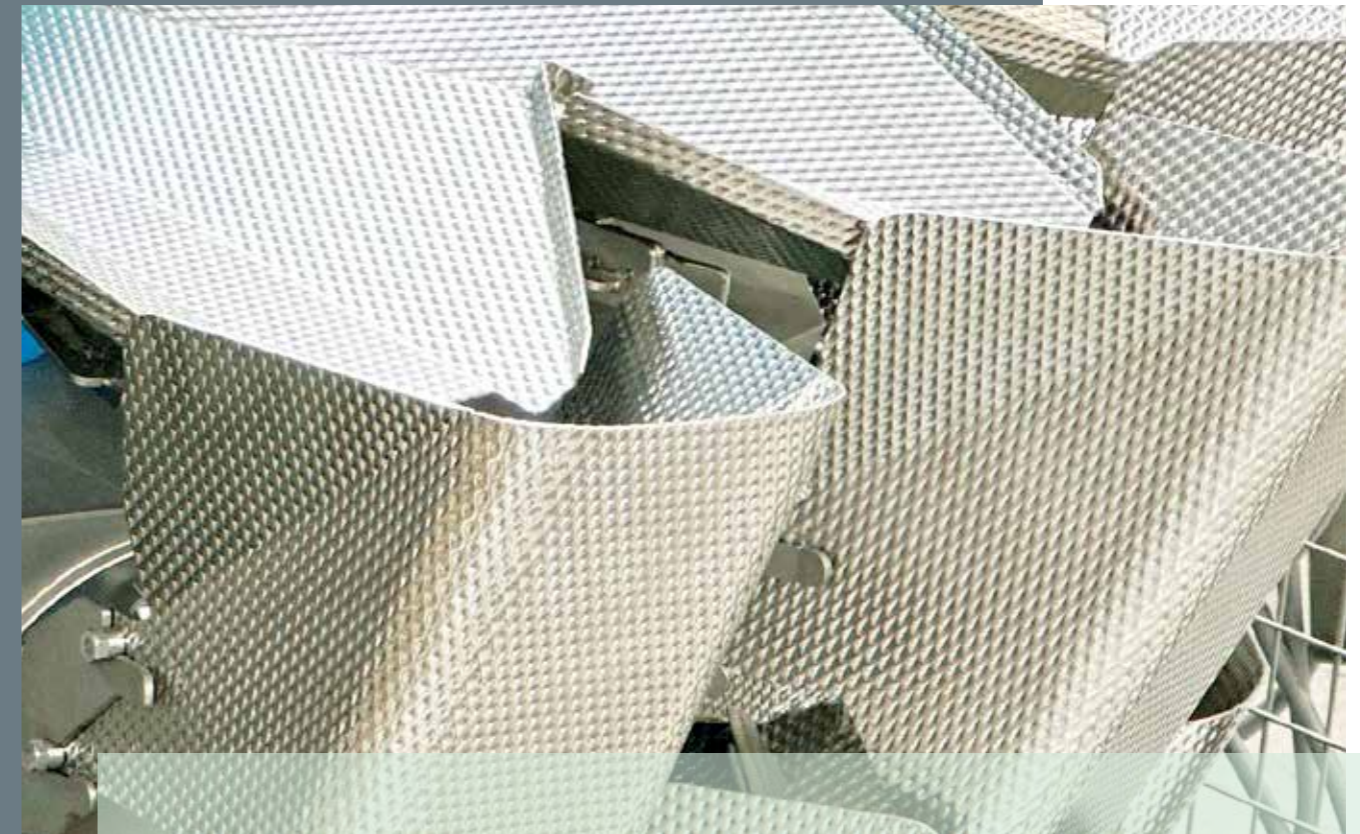

TABLE OF CONTENT



WELCOME 02
To our valued customers

INTRODUCTION 05
Who we are

FOOD AND NONFOOD 10
The Bilwinco multihead weigher programme for dry and wet products

HARDWARE 13
Specifically engineered to tackle rugged, heavy hardware products with accuracy

WHY CHOOSE US? 16
Your trusted partner since 1955

INTRODUCTION

MULTI • CHECK
we know what's inside

WHO WE ARE



RELIABLE PARTNER IN WEIGHING AND PACKAGING SOLUTIONS

As a leading manufacturer serving the food, non-food, and hardware industries, BILWINCO takes pride in crafting tailored solutions that precisely meet your needs. Our expertise lies in ingeniously combining existing technologies and machines to create innovative solutions, ensuring your operations run smoothly and efficiently.

What sets us apart is our unwavering commitment to quality and reliability. With a focus on building long-term relationships, we prioritize understanding your business and its unique challenges. This understanding forms the foundation upon which we deliver impactful solutions that make a difference.

FAMILY-OWNED BUSINESS

BILWINCO is more than just a company; we are a family-owned business with roots dating back to 1955. Based in Hjørring, Denmark, with a presence in Chicago, USA. Since the very beginning, we have continually enhanced our machinery, adding intelligence and innovation with each iteration. Today, both generations of the Pedersen family - Claus and Gitte, along with their sons Martin and Michael - are actively involved in our daily operations. Their leadership ensures the highest quality solutions and seamless delivery and installation.

Our relentless pursuit of quality and innovation has not only allowed us to keep pace with technological advancements but also positioned us as industry innovators, setting international standards in various segments. At BILWINCO, we are not just your supplier; we are your reliable partner, dedicated to your success.

COMPANY VISION

VISION

Our vision is to become the preferred provider of solutions, seamlessly meeting our partners' evolving process needs, leading to substantial cost savings and notable output enhancements. We aim to be the most innovative company, adept at adapting to the dynamic landscape, and aspire to be the top choice for businesses seeking efficient and effective solutions that foster sustainable growth and success.

MISSION

Our mission is to provide tailored modular solutions that prioritize simplicity and optimization, meeting partners' evolving process needs to generate savings and drive increased output.





TAILORMADE
SOLUTIONS

A few examples of different solution for a variety of customers worldwide. With our inhouse production we are known for our ability to adapt every solution to our customers' needs.

01



05



06



07



02

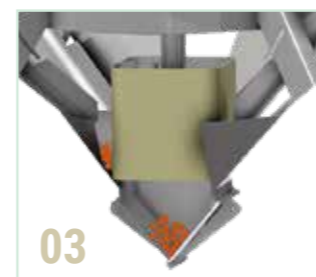

03



04



08

01

A solution tailored for marinated olives and vegetables, featuring a washing wall mounted on the platform for effortless cleaning.

02

Triple-line solution designed for rapid shifts in output, ensuring continuous production with minimal downtime.

03

Soft drop features and strong seamless rubber coating ensures gentle and careful handling of your threaded products.

04

Custom loading system for cereals.

05

Example of one of our numerous mobile solutions offering maximum flexibility in production.

06

A comprehensive solution for heavy products, accommodating containers up to 1 ton each. Packed in both cartons and KLT containers.

07

A fully automated and intricate production line for packing fasteners at high speeds.

08

A dual-linear solution designed for high-production environments with multiple shifts and lengthy product dimensions.

FOOD AND NONFOOD

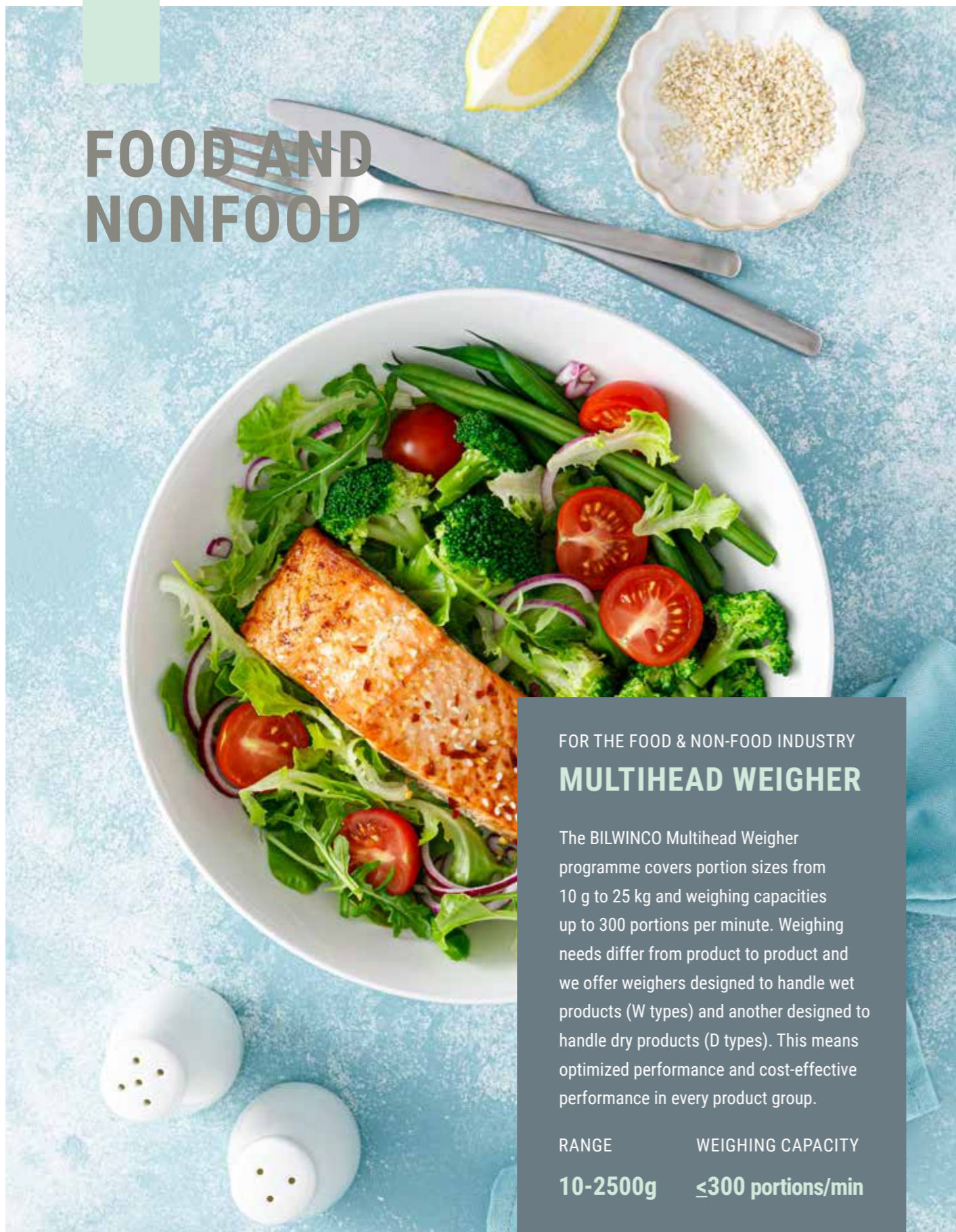

FOR THE FOOD & NON-FOOD INDUSTRY **MULTIHEAD WEIGHER**

The BILWINCO Multihead Weigher programme covers portion sizes from 10 g to 25 kg and weighing capacities up to 300 portions per minute. Weighing needs differ from product to product and we offer weighers designed to handle wet products (W types) and another designed to handle dry products (D types). This means optimized performance and cost-effective performance in every product group.

RANGE	WEIGHING CAPACITY
10-2500g	≤300 portions/min



MULTIHEAD **REVOLUTION WEIGHER**

By completely rethinking the way we handle your product, from the product infeed over the centre cone and into the individual Weigher Heads we have accomplished nothing less than a performance leap in this crucial area. Our vibrator technology can be set to move almost any product carefully and efficiently, including difficult products such as wet, sticky, greasy, and fragile products.



MULTIHEAD **COMPACT REVOLUTION**

With an overall compact design and advanced self-tuning control for vibratory pans, the C-Series guarantees high-speed weighing with unparalleled accuracy. The new control system operates with increased resolution and a processing speed three times faster than before. Seamless and precise product flow to the double-gate buckets at low drop heights is just one reason we excel in this field.

DEPENDABLE WEIGHING SYSTEMS ENGINEERED FOR LONGEVITY

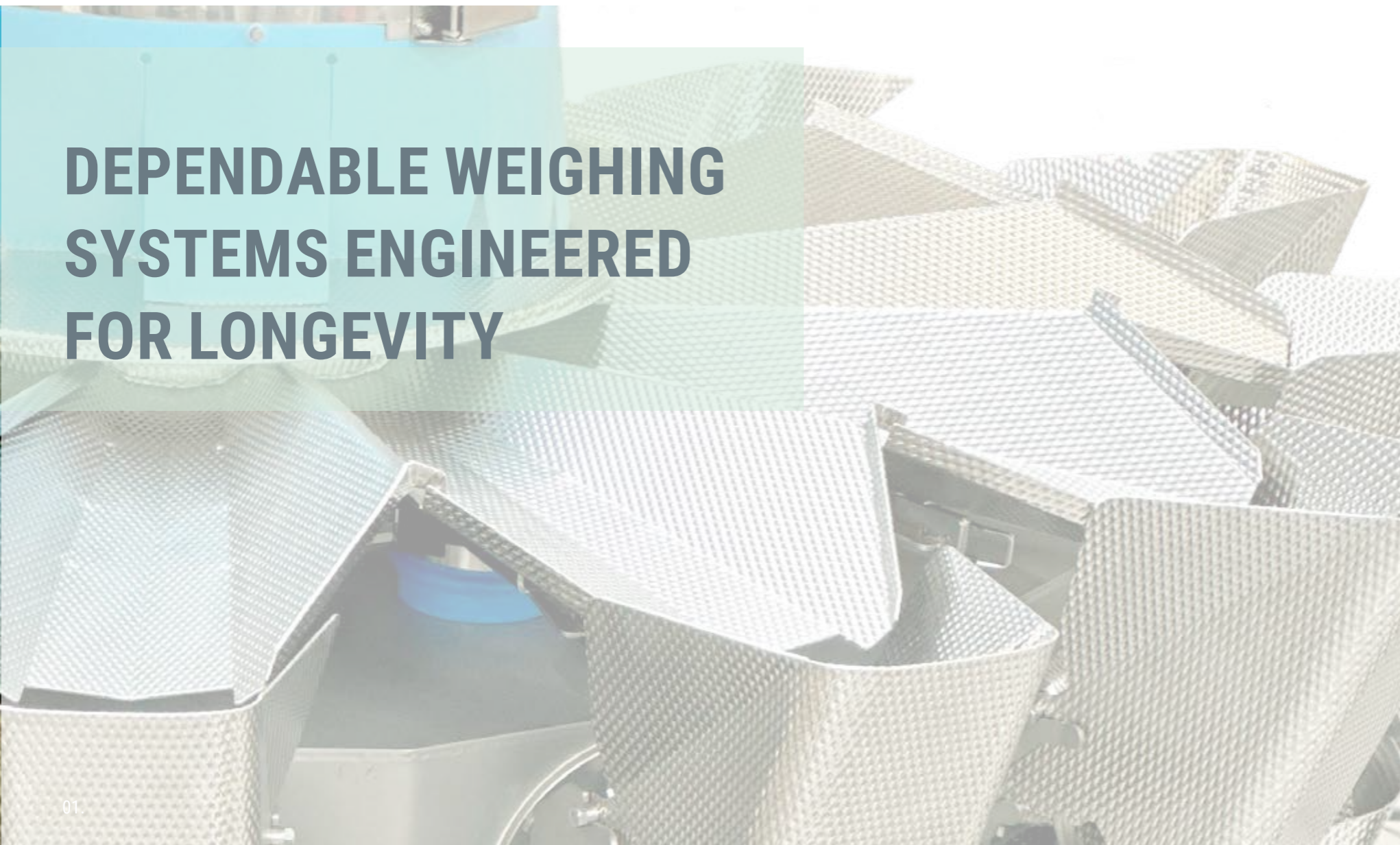

01. BUILD TO LAST

BILWINCO weighers offer a higher constant throughput with high power and superb vibrator technology. Productivity is kept high, and our weighers handle products no-one else can. The direct weighing ensures 20-30% less giveaway.

With all components manufactured in-house, each system undergoes rigorous assembly and testing before shipment, ensuring top-notch quality and reliability.

02. BEST LOAD CELL ON MARKET

As the sole Multihead Weigher in the market, we provide an unparalleled load cell that is unbreakable and reliable. Our advanced technology allows for gasket-free direct weighing, along with a robust 300% overload protection in all directions. Our innovative design ensures longevity and durability. You can expect maximum uptime, while minimizing giveaways and reducing the overall cost of ownership.

03. EASY OPERATION

With a generous 15" screen, this user-friendly interface offers OEE readings (Operating Equipment Efficiency), Statistical data, Help and Trouble Shooting Menus, and so much more.

04. LOWEST TCO

Our multihead weighers stand out for their innovative gasket-free direct weighing feature, guaranteeing accuracy and slashing giveaway by 25% compared to traditional models. Easy-to-replace wear parts keep repair costs minimal. This translates to the lowest total cost of ownership (TCO) in the market, with swift return on investment.

05. RELIABLE SCALE BUCKETS

Our durable scale buckets prioritize convenience and hygiene, featuring interchangeable stainless steel construction for easy cleaning. Their larger size sets them apart, catering to diverse product sizes and portion volumes.

06. HIGHLY EFFECTIVE VIBRATOR

Achieving top speed and accuracy hinges on flawless product transport. BILWINCO's high-power vibration system, adaptable in frequency and amplitude, stands out. Renowned since 1955, BILWINCO customizes each machine's routine to ensure optimal settings tailored to specific product and project needs.

07. HYGIENIC DESIGN

Ensuring easy access to scale controls is vital. Our Multihead Weigher, known for hygiene, features waterproof cabinets. Details like protected doors enhance sanitation. With IP67 waterproofing, it withstands frequent cleanings. Fully welded, it eliminates unhygienic edges. Self-draining design prevents moisture buildup.

MOBILE SYSTEMS OFFER HIGH FLEXIBILITY IN PRODUCTION

WEIGHER, INFEED, AND DISTRIBUTION MOBILE UNITS

The infeed system and filling tool can also be supplied as mobile units, forming a complete mobile weighing and packaging system. Mobility is closely linked with optimal hygiene. A weigher on wheels can be easily moved away from your packaging line for thorough high-pressure wash-downs, and you can lower the weigher to the floor for more efficient cleaning. The mobile infeed system can also be lowered and wheeled away from the line along with the weigher. The ease of maintenance is obvious when the weigher is located away from the packaging line.

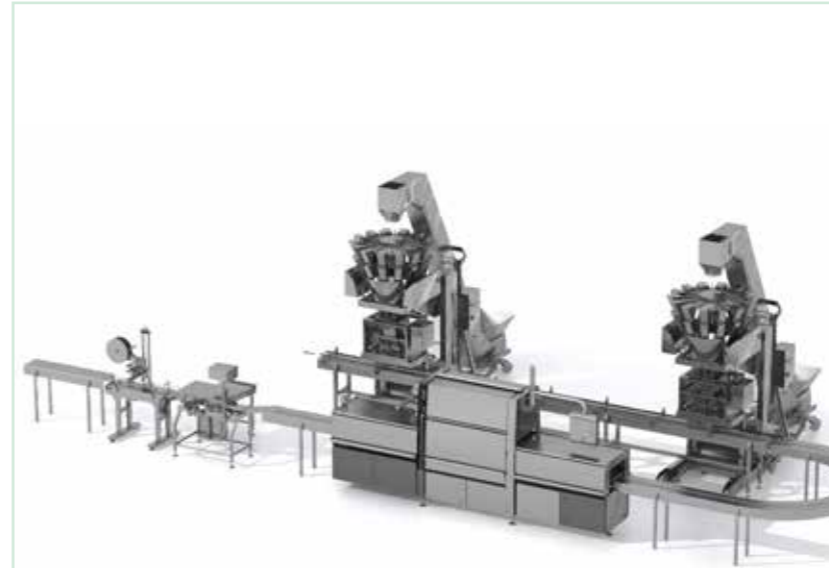

FOR HIGH FLEXIBILITY CHOOSE A MOBILE SOLUTION

By leveraging the capabilities of a flexible and mobile solution, production becomes more dynamic, unlocking newfound operational efficiency, and ensuring a swift return on investment. Opting for a mobile solution is ideal for integrating production across different lines.



MOBILE INFEED & DISTRIBUTION ROLL AWAY

All BILWINCO equipment can be delivered with a mobile support frame designed for versatile and flexible weighing and packaging processes. A mobile distribution tool is especially beneficial when supplying two distinct tools, such as one for thermoforming applications and another for handling bags.

A BROAD RANGE OF DISTRIBUTION SYSTEMS

The distribution system is tailored to meet diverse needs across various packaging lines. Tools are often interchangeable, allowing for multiple options on the same machine, accommodating different sizes or quantities. We provide distribution tools for various outputs such as tray sealers, thermoformers, bags, cartons, cans, and glass. Both stationary and movable solutions are available.



MOBILE FILLING TOOLS AND FILLING ON THE FLY

To prevent unnecessary waste of valuable production time, we offer solutions for precise high-speed filling, often incorporating a dipping function to ensure accurate dosing even during continuous operation "filling on the fly".

For increased production flexibility or when products are packed in various formats, a mobile filling tool presents an excellent alternative.



CUSTOM-MADE TOOLS ARE AVAILABLE FOR DISTRIBUTION

KNOWING YOUR PRODUCT MAKES THE DIFFERENCE

BILWINCO offers practical and profitable solutions tailored to operate seamlessly in your production round the clock, every day of the year. We excel in optimising your production process from design to servicing. Our expertise spans across practically all types of products. We customise solutions after thorough analysis of your products, production, and potential challenges. Our offerings include semi or fully automatic units covering feeding, Multihead Weighing, filling, portioning, positioning, packaging, and data management, along with comprehensive service. Our focus is on enhancing productivity, reducing maintenance expenses, and boosting your profitability.



EFFICIENT CLEANING MAXIMUM HYGIENE STANDARDS

ENHANCED HYGIENE SOLUTIONS WASHING & CLEANING

A comprehensive solution for washing and cleaning is essential. The process and packing equipment must be easy to clean. BILWINCO has developed a weighing and packing principle that prioritises cleaning friendliness, bacteria-preventive designs, and materials tolerant of aggressive environments, such as those found in the wet food industry. All equipment - feeding, weighing, and filling systems, etc. - is designed with the utmost attention to hygiene standards. Additionally, we offer supplementary machinery to ensure improved cleaning standards.



A BROAD RANGE OF WASHING TOOLS WASHING TROLLEYS

BILWINCO can deliver a wide variety of washing trolleys, ensuring efficient and secure cleaning for different solutions and distribution options. No tools are required for dismantling the product zones for cleaning. The weigher features an open design to ensure easy access for cleaning. A washing wall can be mounted on a platform solution for easy access and to avoid heavy lifting.

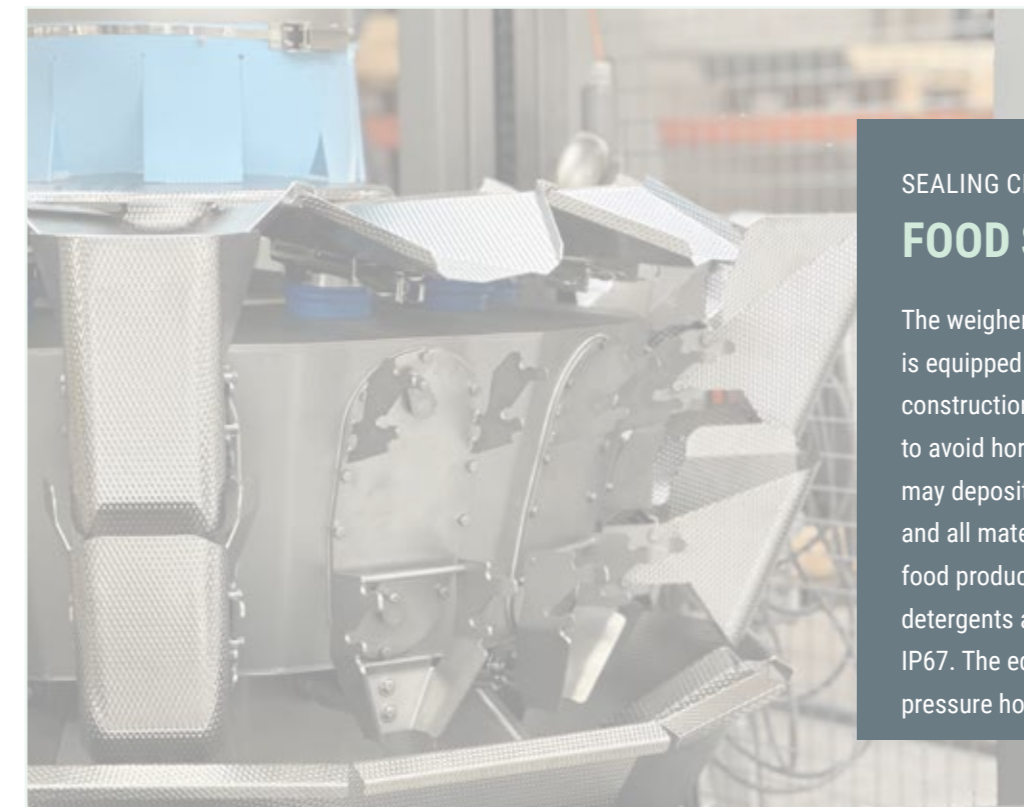

SEALING CLASS IP67 FOOD SAFETY ENSURED

The weigher is built up around a cone or is equipped with an overhang. All tube constructions and profiles are "prism-design" to avoid horizontal surfaces where residues may deposit. All joints have been fully welded and all materials are certified for use with food products and withstand aggressive detergents and disinfectants. Sealing class IP67. The equipment withstands high-pressure hosing.

TECHNICAL DETAILS

COMPACT SERIES

MULTIHEAD WEIGHER FOR FOOD & NON-FOOD

RW100 - COMPACT SERIES	RW120W-C	RW124W-C	RW132W-C
Heads	20	24	32
Maximal Product Size (mm)	Ø 25	Ø 25	Ø 25
Bucket Sizes (l)	0.6-1	0.6-1	0.6-1
Portion Volume (l)	1-2	1-2	1-2
Accuracy (g)	+/- 0.5-1	+/- 0.5-1	+/- 0.5-1
Capacity Theoretically (ppm)	120/230	120/240 Can be divided into 2 or 3	140/280 Can be divided into 2, 3 or 4
Capacity Real (ppm)	TBD - depending on specific product / solution		
Diameter (mm)	Ø 1550	Ø 1640	Ø 1860
Height (mm)	H 1150	H 1150	H 1400
Weight (kg)	~700	~800	~1200
Pneumatic Actuators	•	•	•
Electrical Actuators	•	•	•

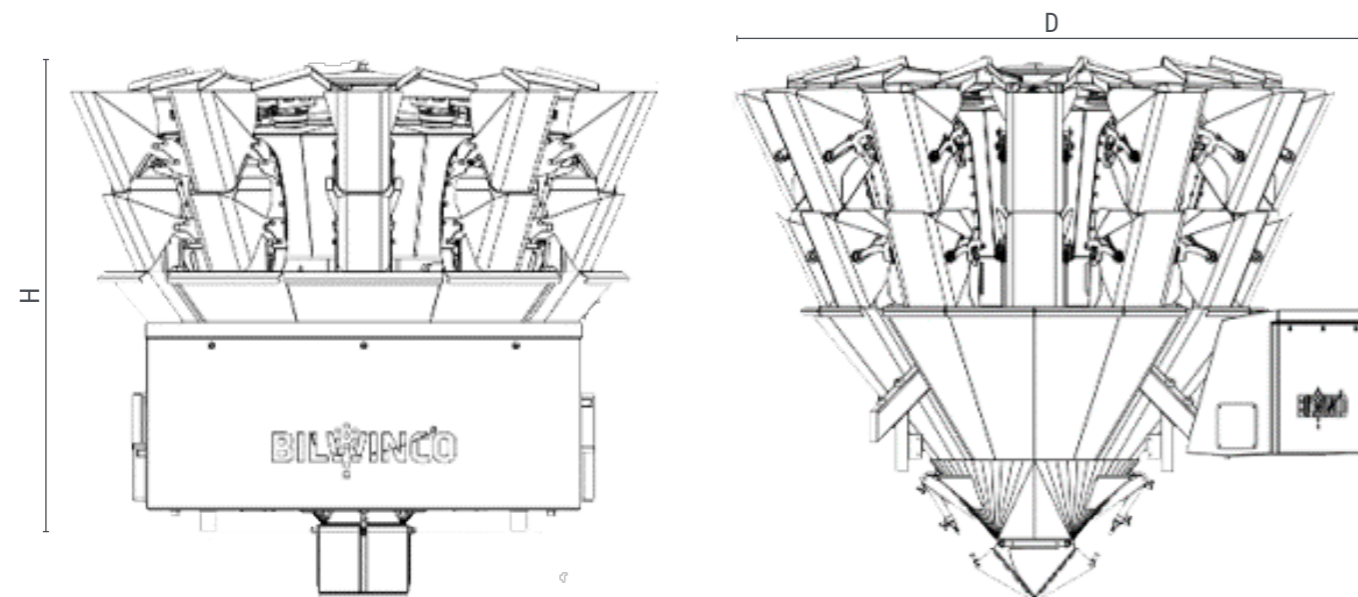

TECHNICAL DETAILS



REVOLUTION 100 SERIES

MULTIHEAD WEIGHER FOR FOOD & NON-FOOD

RW100 - SERIES - WET/DRY	RW110W/D	RW112W/D	RW114W/D	RW116W/D	RW120W/D	RW124W/D
Heads	10	12	14	16	20	24
Product Size (mm)	2-150	2-150	2-150	2-150	2-130	2-130
Bucket Sizes (l)	1-2-3	1-2-3	1-2-3	1-2-3	1-2	1-2
Portion Volume (l)	3-8	3-8	3-8	3-8	3-5	3-4
Accuracy (g)	+/- 0.5-1	+/- 0.5-1	+/- 0.5-1	+/- 0.5-1	+/- 0.5-1	+/- 0.5-1
Capacity Theoretically (ppm)	110	120	136	140	Undivided 177 Divided 110-110=220	Undivided 220 Divided 120-120=240
Capacity Real (ppm)	TBD - depending on specific product / solution					
Diameter (mm)	Ø 1446	Ø 1465	Ø 1490	Ø 1497	Ø 1672	Ø 1874
Height (mm)	H 1130	H 1130	H 1130	H 1130	H 1130	H 1130
Weight (kg)	~375	~440	~490	~540	~490	~540
Pneumatic Actuators	•	•	•	•	•	•
Electrical Actuators	•	•	•	•	•	•

REVOLUTION 200 SERIES

MULTIHEAD WEIGHER FOR FOOD & NON-FOOD

RW200 - SERIES WET	RW212W	RW214W	RW216W	RW220W
Heads	12	14	16	20
Product Size (mm)	2-180	2-180	2-180	2-130
Bucket Sizes (l)	5-7.5	5-7.5	5-7.5	5-7.5
Portion Volume (l)	3-20	3-20	3-20	3-20
Accuracy (g)	+/- 1-2	+/- 1-2	+/- 1-2	+/- 1-2
Capacity Theoretically (ppm)	100	110	120	90/120
Capacity Real (ppm)	TBD - depending on specific product / solution			
Diameter (mm)	Ø 1875	Ø 1949	Ø 2042	Ø 2402
Height (mm)	H 1300	H 1300	H 1300	H 1300
Weight (kg)	~840	~990	~1140	~1360
Pneumatic Actuators	•	•	•	•
Electrical Actuators	•	•	•	•

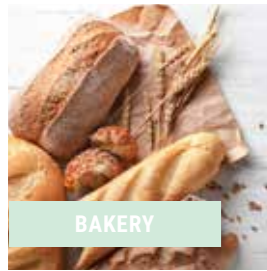

BAKERY

New and advanced packaging-styles with special features are constantly being developed and brought to the market. Your delicate products must be displayed in a unique way, making your products look better than others. Accurate, gentle, and special handling of your products is key in every BILWINCO solution.



CEREAL | GRAIN

Grain and cereals are by nature not free from dust, and it can be a harsh environment. Furthermore, grains and cereals, their inherent versatility becomes essential for seamlessly accommodating the constant influx of new products and diverse packaging types along the production line.

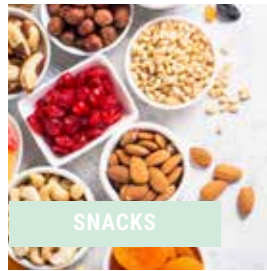

SNACKS

The industry has rapidly expanded, driven by changing consumer preferences and demand for convenient on-the-go options. With a diverse array of products like chips, nuts, and crackers, the industry continually innovates to meet evolving tastes. Quick product development and packaging convenience cater to modern lifestyles.



CONFECTIONARY

We prioritize versatility and tailored handling for accommodating new confectionery products and packaging types. Our expertise minimizes product damage and breakage, preserving the delicate integrity of confectionery items. We strive to maintain the utmost care in conveying goods and managing packaging speed.



MEAT | POULTRY

Accurate and precise measurements are paramount when dealing with meat products, particularly in adhering to fixed weight packaging requirements. Our Multihead Weighers excel in delivering highly accurate portioning, ensuring consistency and compliance with specified weight standards in the industry.



SEAFOOD

Seafood is a high-value product, so precision in weighing is crucial. The ability to precisely measure and distribute portions helps minimize giveaway, ensuring that the correct amount of product is included in each package. This contributes to cost savings and improved profitability.



DAIRY

BILWINCO solutions specialize primarily in applications within the cheese industry, catering to various types such as shredded, diced, or cottage cheese. These cheeses, regardless of their form, often present unique characteristics, being solid yet still retaining moisture and frequently described as sticky.

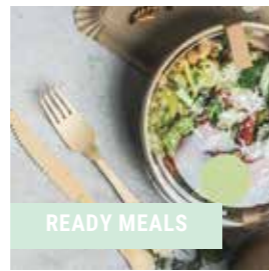

READY MEALS

BILWINCO Multihead Weighers are renowned for their high-speed operation, making them suitable for the fast-paced demands of ready meals processing to increase production efficiency, helping to meet high-volume requirements packed in various formats, including trays, pouches, or containers.



GREENS | VEGETABLES

Both the greens and vegetables industries have evolved from traditional, uniform products to multifaceted segments that cater to diverse consumer preferences. Key drivers of this transformation include a commitment to quality, sustainability, innovation, and the global dissemination of greens and vegetables culture.



PICKLED | PRESERVED

Stickiness and clumping can impact the accuracy of the weighing process by hindering the smooth flow of products through the weigher's buckets. Our specially designed scraper hopper ensures a consistent and accurate weighing process. The density of foods varies, requiring different designs for product reception.



COFFEE | TEA

Coffee and tea are high value products so precision in weighing is key. The ability to precisely measure and distribute the portions helps minimize giveaway, ensuring that the correct amount of product is included in each package. This contributes to cost savings and improved profitability.



FOOD APPLICATIONS

YOUR CHALLENGE IS OUR SOLUTION

PRECISION FOOD WEIGHING FOR PACKAGING SUCCESS

We recognize that each food product presents unique challenges in the packaging process. Our dedicated team of sales specialists and engineers is poised to offer expert advice and craft tailored solutions to address the distinctive requirements of your product.



BILWINCO weighers are designed for minimizing give-away in weight-based applications, ensuring accurate and efficient packaging. Whether your products demand high precision or require specialized packaging conditions, our Multihead Weighers provide the versatility and efficiency needed to meet your goals.

Explore the examples of diverse applications where we can collaborate in constructing a customized solution that precisely caters to your specific weight-based needs.

NON-FOOD APPLICATIONS

EXPLORE THE POSSIBILITIES



ENDLESS OPPORTUNITIES WITH WEIGHER SOLUTIONS

Discover endless possibilities unleash a world of opportunities with our premium weigher solutions. With a wealth of experience and a proven track record of over 6,000 successful installations, we recognize that each non-food product comes with unique challenges in the packaging process.

Our committed team of sales specialists and engineers is ready to offer expert guidance and craft tailored solutions that address the distinct requirements of your item.

Going beyond mere weight considerations, all BILWINCO weighers feature the ability to count pieces, empowering you to effortlessly create packages based on predetermined quantities. Whether your products require precision or specialized packaging conditions, our Multihead Weighers provide unparalleled versatility and efficiency.

Explore a myriad of applications where we can collaborate to build a customized solution that perfectly aligns with the specific needs of your non-food product.



PHARMACEUTICAL

Accurate and precise measurements are paramount when dealing with pharmaceuticals like Vitamins and Minerals, Pills and tablets, Needles, Medicine wrapped in blisters, and other.



CANNABIS

Cannabis is a high-value product, so precision in weighing is crucial. The ability to precisely measure and distribute portions helps minimize giveaway, ensuring that the correct amount of product is included in each package eg. Dried Flower and Leaves, Concentrate, Pre-rolls and Joints, Seeds and Cultivation, and other.

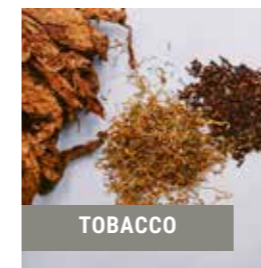

TOBACCO

BILWINCO solutions easily pack tobacco products like Chewing tobacco, Cigarettes and Cigars, Rolling Tobacco and Leaves, Pipe Tobacco, Nicotine Replacement, Hookah and Shisha, Filters and Accessories, and other.

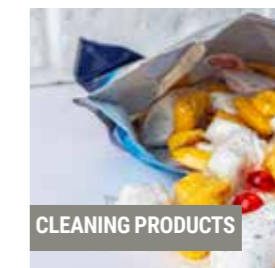

CLEANING PRODUCTS

Dishwasher Tablets and Cups, Laundry Capsules and Detergent Powder, Cleaning Tabs and Pods, Surface Disinfectant Cups and Cleaning Tabs, and other are easily weighed and packed with accuracy using a BILWINCO solution.

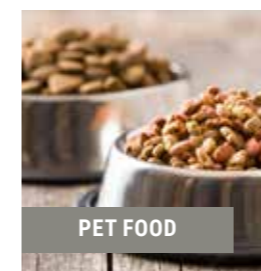

PET FOOD

A comprehensive range of nourishing options awaits for the furry companions. BILWINCO have solution for all kind of petfood like Dog Food, Puppy and Kitten Food, Dry Petfood, Treats and Snacks, Chews, Chewing bones, Chunks, Rabbit food, Bird Seeds, Cat Food, Fish Food, and other.



AGRI BUSINESS

In the agribusiness application, precision and efficiency are pivotal in optimizing agricultural processes. We offer solutions for all kind of Seed Distribution, Animal Feed, Vitamin Mixes, Fertilizer Blends, Forage and Silage Additives, Herbicide and Pesticide Packaging, Livestock Supplements, Mineral Mixes, and other.

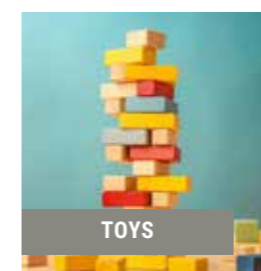

TOYS

In the world of toys, precision and efficiency play a crucial role in delivering joy to young hearts. Examples within this playful realm could be Bricks and Building Blocks, Figures, Plush Toys, Games, Play Equipment, Board Games, Arts and Crafts Kits, Pearls, and other.

CASE STORY

KLÜMPER GMBH



“

If production couldn't be increased within the existing floorspace and ceiling height, we would have had to disappoint our growing customer base or undertake the challenging and costly task of expanding the production facility.

Given our positive experiences with BILWINCO Multihead Weighers in terms of quality, reliability, and local service, it made perfect sense for us to approach BILWINCO for a proposal for a new system. The new weigher is equipped with a user-friendly control system, making operation easier.

Mr. Bernd Egberts
Technical Manager, Klümper GmbH



INTRODUCTION

THE COMPANY

At Klümper, hearty and tender gourmet ham has been a tradition for centuries. The 7th generation of the owners' families feels responsible for maintaining the long tradition as well as constantly developing and improving the company. Since the very beginning in 1821 in Westphalia, Germany, Klümper has been focusing on producing the highest quality cured hams. Today's most delightful delicacies are based on the family's secret recipes. Klümper ham goes through around 30 manual work steps before the ripening process, under constant control and the highest quality standards. To ensure excellent taste, Klümper combines traditional craftsmanship with state-of-the-art production processes.

TO EVERY CHALLENGE THERE IS

A SOLUTION

In light of the limited production capacity within Klümper's current floorspace and ceiling height, expanding the production facilities appeared to be both challenging and prohibitively expensive. However, the introduction of a new weigher with an enhanced and user-friendly control system emerged as a promising solution.

BILWINCO designed a custom-made solution for Klümper, based on a BILWINCO RW120W-AB Multihead Weigher with 20 channels, split into 2 sections of 10 channels each. The entire system included a storage unit and vibrator feeder, a Z-conveyor, a combination filling- and distribution tool to fill 8 or 16 pockets at the time of the Thermoformer, a platform, and a washing wall for the weigher. Despite the use of a larger weigher, BILWINCO managed to design a system that fits within the existing floorspace and ceiling height.



Despite the use of a larger weigher, the system was designed to fit within the existing floorspace and ceiling height.



The high-capacity solution maximized the space and minimized the need for costly facility expansions.



The chosen solution from BILWINCO ensures accurate and efficient portioning in thermoforming.

CONCLUSION

THE RESULT

 **83%** An impressive 83% increase in production

 **0.5%** Less than 0,5% "Give-away"

After installation the production capacity was increased by 83% within the same floorspace and ceiling height as the previous solution. The average "give-away" on the new system is less than 0.5%. The package approval percentage, as indicated by the checkweigher, ranges between 98 and 99%.

This great cooperation between Klümper and BILWINCO has resulted in a solution with significantly higher production capacity within the existing floorspace and ceiling height, representing significant savings compared to expanding or rebuilding the production facility. Due to the positive results with the new system, Klümper will further expand the production of diced ham.

HARDWARE SOLUTIONS



RETAIL & INDUSTRIAL PACKING
HARDWARE SOLUTION

Crafted by our skilled in-house production team, each of our weighers boasts robust construction and components. Specifically engineered to tackle rugged, heavy hardware products, our solutions prioritize accuracy, efficiency, and a conducive working environment with reduced noise levels. We prioritize collaboration, listening attentively, analysing requirements, and tailoring solutions to fit your needs.

RANGE	WEIGHING CAPACITY
10-2500g	≤300 portions/min

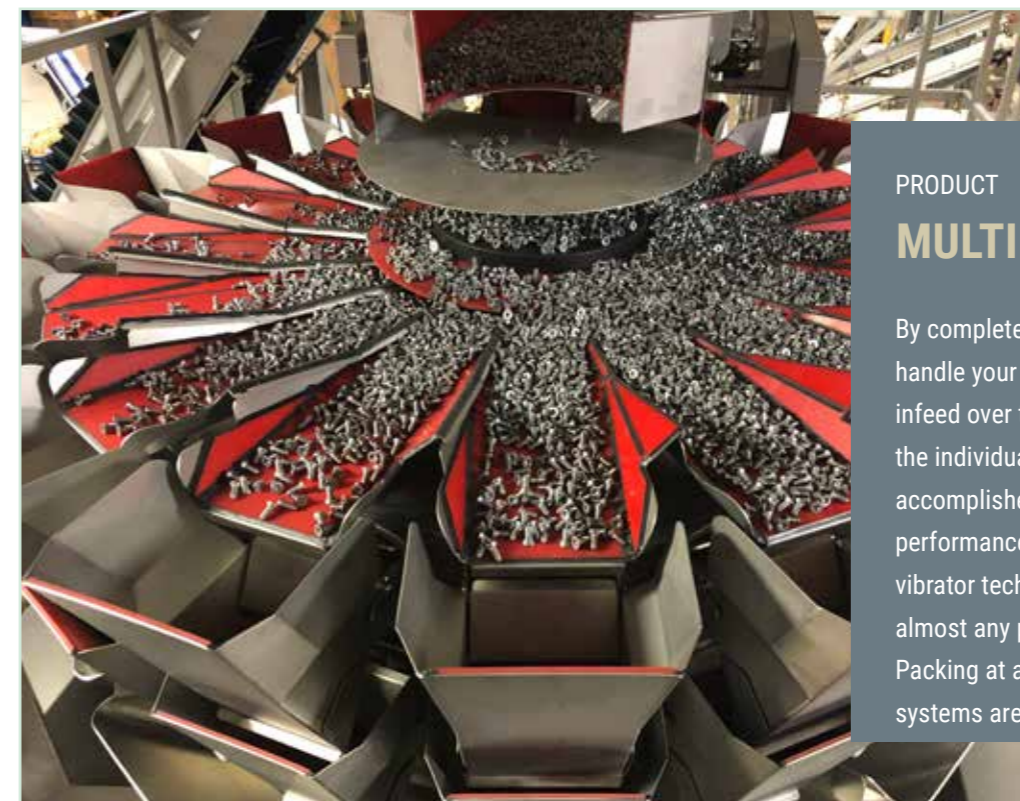

PRODUCT
MULTIHEAD WEIGHER

By completely rethinking the way we handle your product, from the product infeed over the centre cone and into the individual weigher heads we have accomplished nothing less than a performance leap in this crucial area. Our vibrator technology can be set to move almost any product carefully and efficiently. Packing at a higher speed, multihead systems are recommended.

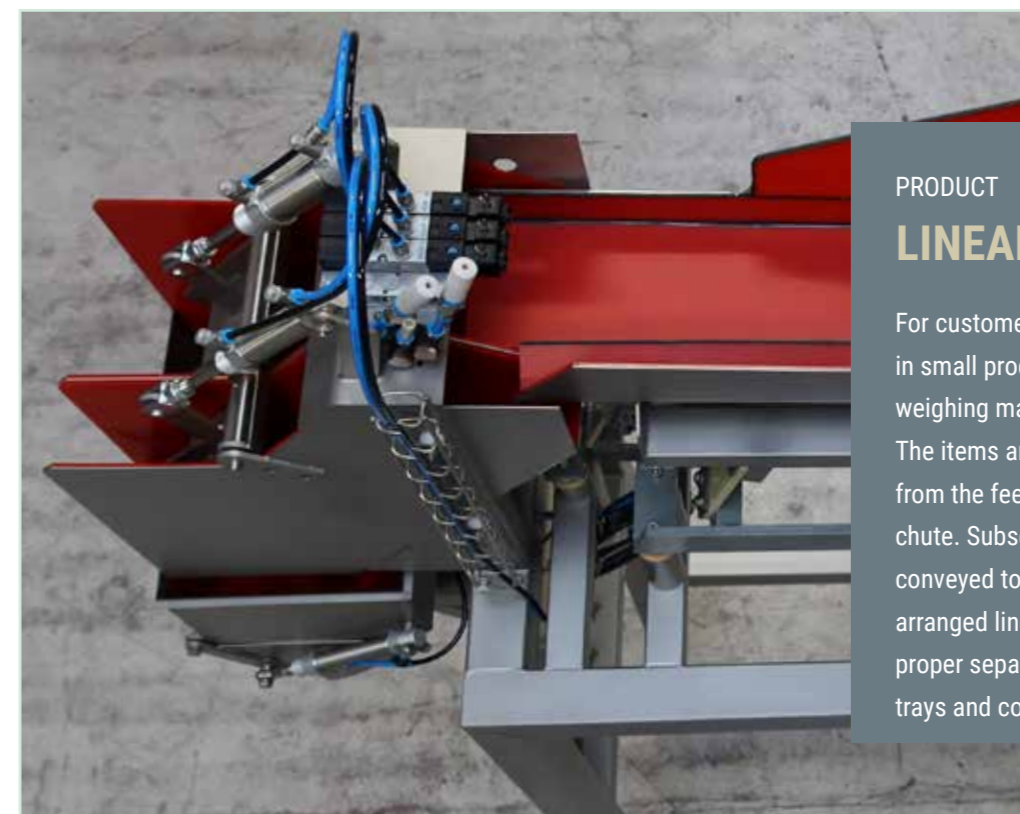

PRODUCT
LINEAR SOLUTION

For customers who want to package hardware in small production quantities our linear weighing machines are particularly suitable. The items are automatically transferred from the feed hopper to the vibrating chute. Subsequently, they are automatically conveyed to both the bulk and fine trays, arranged linearly. Optimal operation relies on proper separation of items in the vibrating trays and continuous supply.

TAILORED SOLUTION FOR YOUR SUCCESS. ROBUST AND RELIABLE.

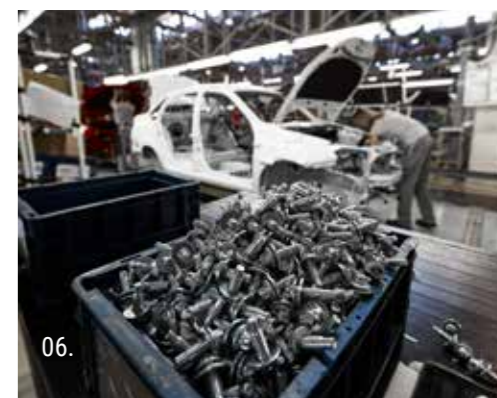
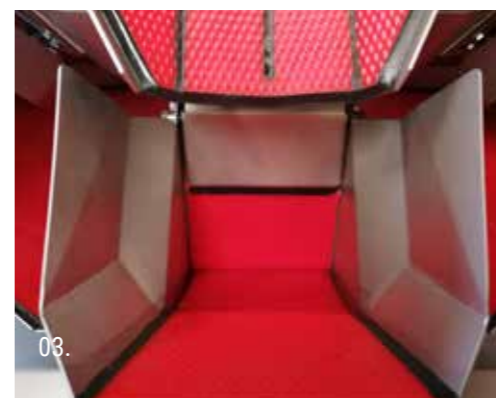
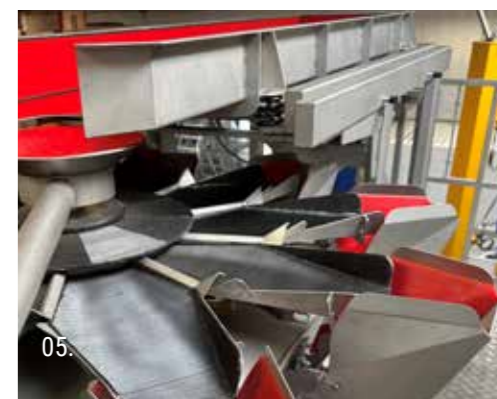

01. EFFECTIVE VIBRATOR

A critical factor in achieving high speed and accuracy is the ability to transport the product flawlessly. BILWINCO excels in this aspect with its high-power vibration, employing flexible frequency and adjustable amplitude.

02. SMALL TO EXTRA LARGE

We supply heavy-duty high-performance weighing, counting, and packaging systems designed for handling fasteners and components such as bolts, electrical components, nails, nuts, plastic parts, rivets, screws, and washers. sizes and styles effortlessly.

03. NOISE REDUCTION

Our durable and reliable scale buckets are covered with a soft coating designed to last, reducing noise, and providing a better work environment. In addition, the rubber coating is beneficial for products that need to be protected.

04. INHOUSE PRODUCTION

Renowned as the best in the market since 1955, BILWINCO ensures that every machine leaving the factory undergoes a customized routine, guaranteeing an ideal amplitude and frequency tailored to the specific product and project requirements. All components are manufactured and assembled in-house.

05. TAILORED TO YOU

Whether heavy, sharp, tricky, or simply special, BILWINCO provides the answer. As the only supplier in the business, we develop our own weighers, controls, and software. This makes us the perfect partner if you are looking for unique solutions custom-made for your special needs.

06. MULTIFUNCTIONAL EXCELLENCE

Embrace versatility with our multifunctional weighers, catering to a spectrum of packaging needs with precision and adaptability in various applications.

07. SUPPORT AND SPARE PARTS

As one of the few producers in the market, we continue to support spare parts for older machines, ensuring ongoing functionality and customer satisfaction. In combination with easily replaceable wear parts reducing downtime and maintenance costs, we guarantee the lowest Total Cost of Ownership on the market!

TECHNICAL DETAILS

HARDWARE 100 SERIES

MULTIHEAD WEIGHER

HW100 - SERIES	RW110H	RW112H	RW116H	RW120H
Heads	10	12	16	20
Maximal Product Size (mm)	120	120	120	120
Bucket Sizes (l)	1-2-3	1-2-3	1-2-3	1-2
Maximum Portion Size	10 kg / 20 lbs	15 kg / 30 lbs	15 kg / 30 lbs	15 kg / 30 lbs
Accuracy (g)	+/- 0.5-1	+/- 0.5-1	+/- 0.5-1	+/- 0.5-1
Capacity Theoretically (ppm)	15-30	20-40	25-60	40-80
Capacity Real (ppm)	TBD - depending on specific product / solution			
Diameter (mm)	Ø 1446	Ø 1465	Ø 1497	Ø 1672
Height (mm)	H 1130	H 1130	H 1130	H 1130
Weight (kg)	~375	~440	~540	~490
Pneumatic Actuators	•	•	•	•
Electrical Actuators	OPTIONAL			

HARDWARE 200 SERIES

MULTIHEAD WEIGHER

RW200 - SERIES	RW210H	HW212	HW216
Heads	10	12	16
Maximal Product Size (mm)	180	180	180
Bucket Sizes (l)	5-7.5	5-7.5	5-7.5
Maximum Portion Size	25 kg / 50 lbs	25 kg / 50 lbs	25 kg / 50 lbs
Accuracy (g)	+/- 1-2	+/- 1-2	+/- 1-2
Capacity Theoretically (ppm)	10-25	10-30	3-20
Capacity Real (ppm)	TBD - depending on specific product / solution		
Diameter (mm)	Ø 1784	Ø 1875	Ø 2042
Height (mm)	H 1300	H 1300	H 1300
Weight (kg)	~710	~840	~1140
Pneumatic Actuators	•	•	•
Electrical Actuators	OPTIONAL		

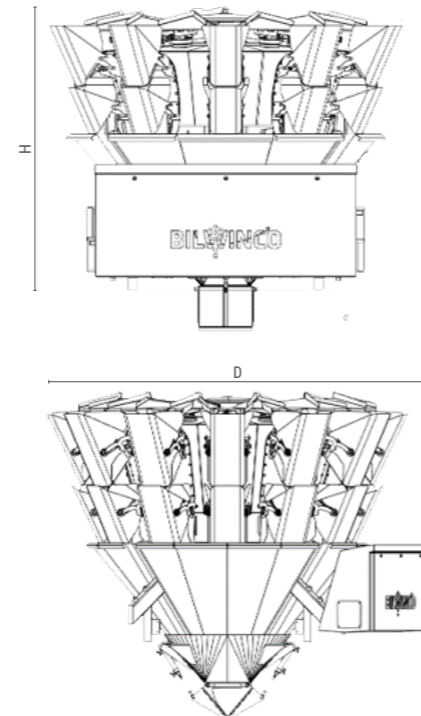

TECHNICAL DETAILS

MULTI • CHECK
we know what's inside

LINEAR SERIES

HARDWARE WEIGHER

LINEAR - SERIES	HW150	HW250
Maximal Product Size (mm)	150 Ø 24	250 Ø 24
Portion Volume (l)	5-10	13-25-50
Accuracy (g)	+/- 0.5-1	+/- 0.5-1
Capacity Theoretically (ppm)	20	15
Capacity Real (ppm)	TBD	
Length (mm)	L 2200	L 2200
Height (mm)	H 800	H 1000
Weight (kg)	~280	~445
Pneumatic Actuators	•	•
Electrical Actuators	OPTIONAL	



PU MODELS

ALIGNMENT

MODEL	1PU15	2PU15	3PU15	1PU30	2PU30	3PU30	4PU30
Dimension Boxes (L x W x H)	250x250x300	250x140x260	250x90x220	350x350x480	350x175x440	350x100x380	150x100x100
Maximal Product Size (kg)	1x15	2x3.5	3x2	1x30	2x9	3x5	4x1
Maximal Product Size (mm)	250	200	160	350	200	180	100
Capacity	4-9/min	8-18/min	12-27/min	4-9/min	8-18/min	12-27/min	20-40/min



HARDWARE APPLICATIONS



AEROSPACE

Small Components Weighing, Hardware and Fasteners, Electrical Connectors, Screws and Bolts, Seals and Gaskets, Cable and Wiring Components, Avionic Instruments, Plastic and Composite Parts, Fluid Connectors and Hoses, Aerospace Adhesives and Sealants, and other.



AUTOMOTIVE

Fasteners and Fixtures, Electrical Components, Plastic and Rubber Parts, Metal Stamping Parts, Suspension Components, Brake System Parts, Engine and Transmission Parts, Interior Trim Components, Fluid System Components, Seals and Gaskets, and other.



CONSTRUCTION

Metal Fasteners and Brackets, Wood and Timber Components, Concrete and Cement Mixes, Insulation Materials, Masonry and Brick Components, Roofing and Waterproofing Materials, Steel Reinforcement Components, Adhesives and Sealants, Electrical and Plumbing Components, Flooring and Tile Components, and other.



FURNITURE

Wooden Panels and Boards, Metal Hardware and Fasteners, Upholstery Materials, Plastic and Composite Components, Foam and Cushioning Materials, Decorative Trim and Moulding, Assembly Kits and Sets, Customized Hardware Packages, and other.

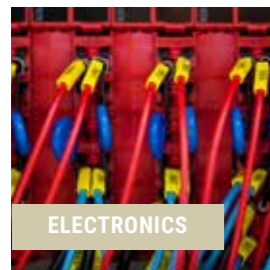

ELECTRONICS

Microchips and Semiconductors, Printed Circuit Board (PCB) Components, Connectors and Wiring Harnesses, Capacitors and Resistors, LEDs and Optoelectronic Components, Electronic Sensors, Battery Components, Identification Tags, Assembly Kits, and Sets, and other.



FASTENERS | FIXINGS

Screws and Bolts, Nails and Staples, Nuts and Washers, Anchors and Dowels, Rivets and Fastening Clips, Screw Covers and Caps, Threaded Rods and Studs, Clamps and Brackets, Bolting Kits and Sets, Customized Fastener Packages, and other.

YOUR CHALLENGE IS OUR SOLUTION

PREMIUM SOLUTIONS FOR THE HARDWARE INDUSTRIES



Each Hardware solution comes with unique challenges in the packaging process. Our committed team of sales specialists and engineers is ready to offer expert guidance and craft tailored solutions that address the distinct requirements of your challenges.

Going beyond mere weight considerations, all BILWINCO weighers, empower you to effortlessly create packages based on predetermined quantities. Whether your products require precision or specialized packaging conditions, our Multihead Weighers provide unparalleled versatility and efficiency.

Explore a myriad of applications where we can collaborate to build a customized solution that perfectly aligns with the specific needs of your Hardware products.



CASE STORY

GJUTERITEKNIK



Our partnership with BILWINCO has been instrumental in overcoming our weighing and packaging challenges at Gjuteriteknik. Their innovative solutions have not only met but exceeded our expectations in terms of accuracy, reliability, and flexibility. With BILWINCO's equipment in place, we've been able to streamline our operations, minimize giveaways, and ensure precision in customer orders. The support and commitment demonstrated by BILWINCO have been exceptional, providing us with peace of mind and confidence in our production processes. We highly recommend BILWINCO to any company seeking reliable weighing and packaging solutions.

Jonas Abrahamsson
CEO, Gjuteriteknik



INTRODUCTION

THE COMPANY

Founded in 1978, Gjuteriteknik has earned recognition as one of Sweden's fastest growing companies. Guided by principles of steady growth, long-term thinking, and reinvestment led by the vision of brothers Jonas and Peter. Specializing in die casting with zinc, they aim to provide a comprehensive production process, taking responsibility for their customers' logistical needs from the design phase onward. Through fully automated processes and state-of-the-art equipment, both flexibility and quality are ensured, delivering products punctually to meet client demands. By heavily investing in the integration of advanced machinery as well as establishing a dedicated training facility, the company is preparing to meet future demands effectively.

GJUTERITEKNIK'S CHALLENGE WAS OVERCOME BY

A BILWINCO SOLUTION

The solution comprises both a linear weigher, the HW250F, ideal for smaller orders necessitating flexible and swift production shifts, and a Multihead Weigher, the RW112H, designed for high-volume operations with a continuous flow packaged in bags. By opting for both types of weighers, the company gains the flexibility to accommodate a diverse product range while minimizing giveaways and ensuring precision in customer orders. Furthermore, for packaging lines that require precision without extensive setups, BILWINCO's linear weigher proves to be an ideal choice. BILWINCO provided a comprehensive solution tailored to their specific needs, complete with built-in future-proofing. The implemented solution not only fulfilled Gjuteriteknik's immediate need to streamline workflows but also yielded significant returns. Within a remarkably short period, the initial investment was recouped. This was primarily due to the newfound operational efficiency, which freed up full-time positions to be allocated to other functions within the production facility.



A recent expansion, adding 1000 m² of production space, has facilitated a more efficient workflow within the factory.



With success both a linear and a Multihead Weigher have been installed.



The chosen solution from BILWINCO has led to significant optimization of production processes.

CONCLUSION

THE RESULT

ROI An impressive ROI due to newfound efficiency

TCO Wear parts are easily replaceable, significantly lowering the TCO

In a closely collaborative partnership between Gjuteriteknik and BILWINCO, a seamless solution was discovered to efficiently handle a diverse array of products, leading to significant optimization of production processes. BILWINCO not only provided renowned weighing equipment but also supplemented it with an infeed system. This comprehensive system empowered Gjuteriteknik to manage a broad spectrum of products, resulting in substantial enhancements to production processes. The solution seamlessly adapted to evolving production demands and seasonal fluctuations, contributing to improved productivity and profitability. Furthermore, establishing enduring relationships with reliable backup support and the potential for system updates was deemed paramount in the decision-making process.

WHY CHOOSE US?

BILWINCO has manufactured weighers since 1955 and is the only supplier on the market who exclusively designs and manufactures Multihead Weighing solutions.

YOUR PREFERRED PARTNER

BILWINCO

Our dedicated team of sales specialists and engineers is poised to offer expert advice and craft tailored solutions to address the distinctive requirements of your product. Let us help you find the most suitable solution to your need.

CALL US TODAY!

+45 86 51 06 66

01. ACCURATE & RELIABLE

BILWINCO weighers have been designed for precision in weight-based applications, ensuring accurate and efficient packaging since 1955.

02. MAXIMIZING ROI

With over 6,000 installations worldwide, we've assisted our customers in optimizing production, resulting in enhanced efficiency, reduced operational costs, and frequently achieving a return on investment in less than one year.

03. LOWEST TCO

As a leading market producer, we support spare parts for older machines, ensuring ongoing functionality and satisfaction. With easily replaceable wear parts, we guarantee the market's lowest Total Cost of Ownership!

04. HYGIENIC DESIGN

With an IP67 waterproof rating, our weighers are guaranteed to withstand multiple sanitations throughout the day.

05. HIGH PERFORMANCE

A weighing solution from BILWINCO is renowned for its design and high quality. Our machines are built to last, providing customers with reliability they can depend on.

06. EFFICIENT SUSTAINABLE

In-house production, durability, easily replaceable wear parts, and long-term support are just a few examples of why we assert that BILWINCO weighers are sustainable.

07. TAILORMADE SOLUTIONS

We take pride in crafting unparalleled solutions tailored for the most demanding production environments, where downtime is simply not acceptable.

08. SUPPORTING YOU

Whether your installation is small or large, with a new or several years old weigher, we are ready to provide all the support you need.

QUALITY SINCE 1955



Supporting the industry since the mid-1950s, we have provided reliable and accurate weighing solutions that enhance our customers' production efficiency and reliability. While our weighers may have evolved in appearance over the years, our commitment to quality remains unwavering. Many of our machines have been in operation for over 30 years, a testament to their durability and longevity. As one of the few producers on the market, we continue to support spare parts for older machines, ensuring ongoing functionality and customer satisfaction.

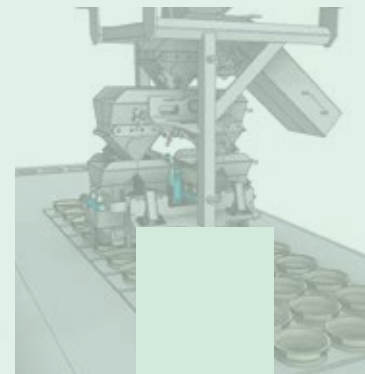
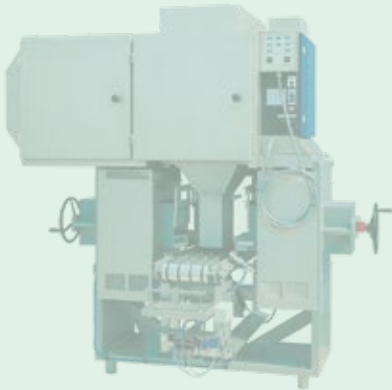
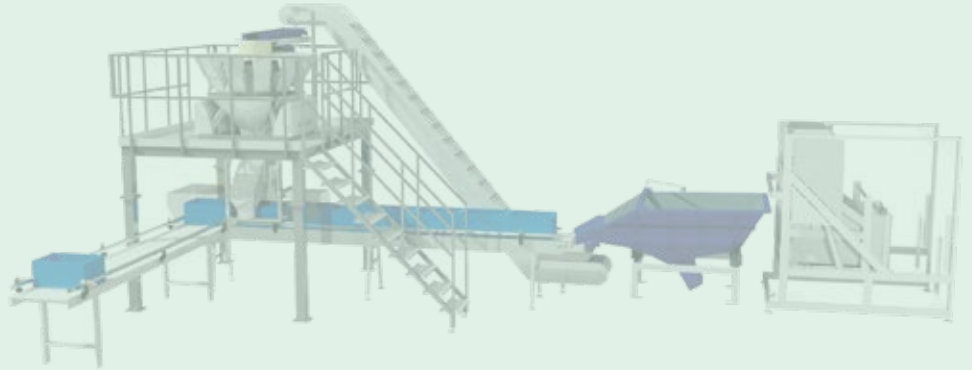
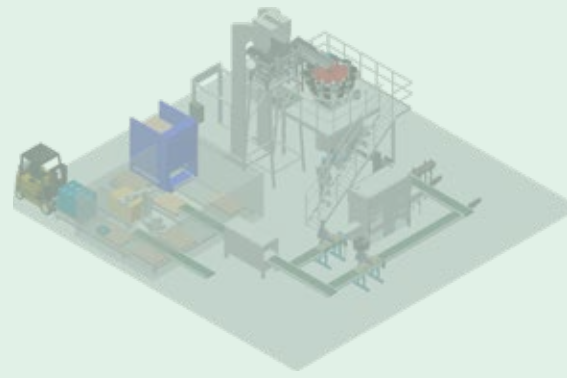

BILWINCO*

MULTI • CHECK

we know what's inside

BILWINCO A/S
Hedevej 3, DK-9800 Hjørring
Denmark

info@bilwinco.com
www.bilwinco.com
DK: +45 86 51 06 66
US: +1 917 91 59 629

